

PD2-3024-8(A)

Model name	PD2-3024-8(A)
Input voltage(rating)	100 to 240 VAC
Power consumption	78 VA
Output connector	3 P (1: +, 2: NC, 3: -) x 8
Weight	1500 g

Units: mm

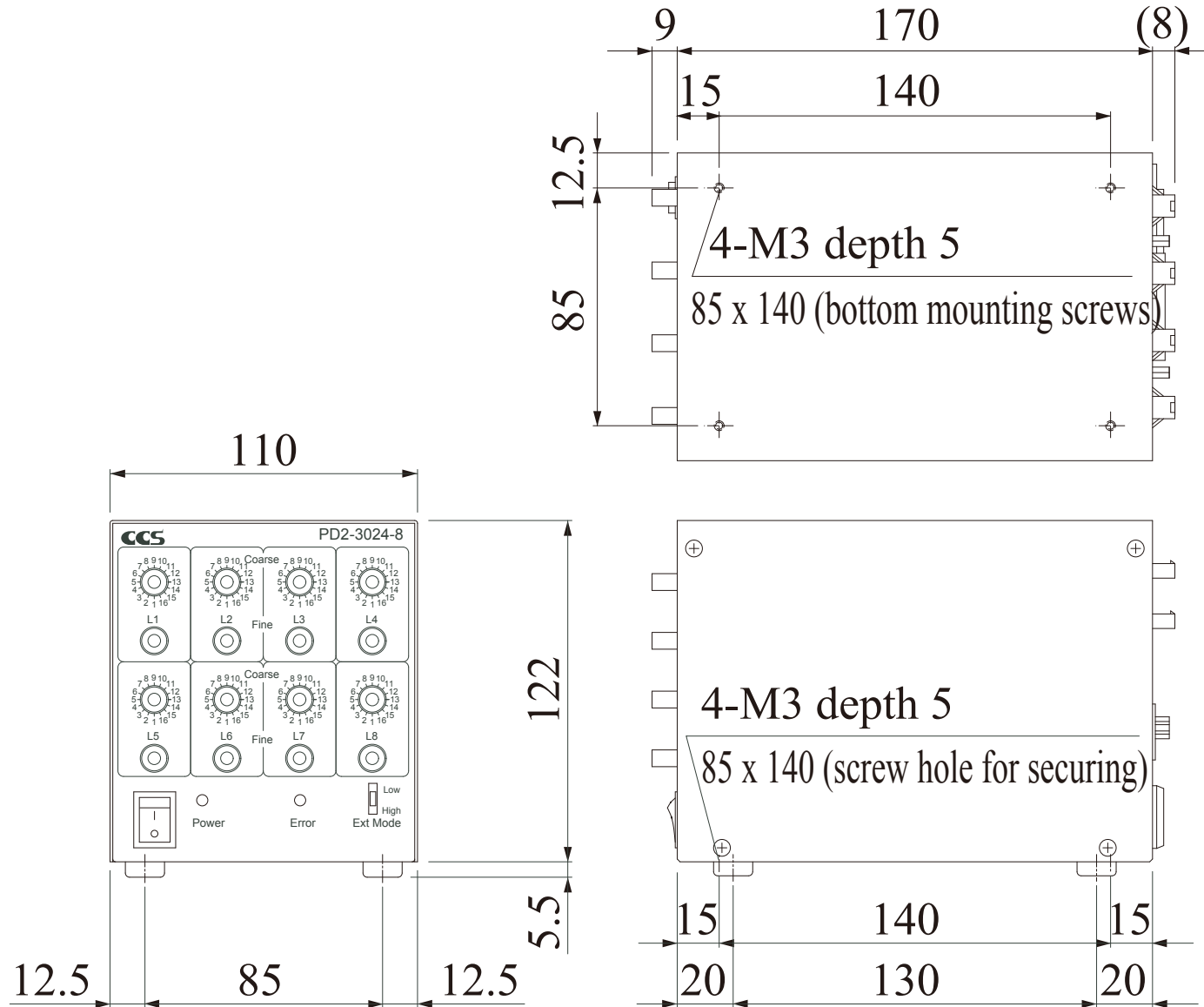

External control connector
D-Sub25pin

